

VIDAA TV

USER MANUAL

Before using the TV, Please read this manual thoroughly, retain it for future reference.

English

RSAG2.025.4850SS

条形码定位框，长 35mm，高度请根据长度等比例缩放。该定位框不做印刷处理。物料号：





Tips

Before using the TV, Please read this manual thoroughly, retain it for future reference. Our company does not assume any liability for any accident arising from violation of the matters of attention and instruction on use in this manual.



This product involves high voltage. The user may not open the cabinet without authorization. Any person other than the repairer may not repair and replace parts without authorization to avoid shock and fire accidents.



Please clean and maintain the entire TV set with clean and soft cotton cloths, and repeated forcible cleanings are prohibited.

The screen may not be scribed, tapped, impacted with hard objects or rubbed with any grinding materials.

During placement and use, the product should be kept from water droplet and splash. In case of adverse weather e.g. thunderstorm, the power plug and cable TV (or outdoor antenna) plug shall be rapidly pulled off to avoid damage due to lightning strike.

Still images can result in permanent damage to TV screen.

1. The time for displaying static images on the LCD TV screen may not exceed 2 hours, otherwise it will result in residual image on the screen. To avoid this, you need to lower the screen brightness and contrast when displaying the still images.
2. When viewing 4:3 format program over long time, different traces will be left on the left and right sides of the screen and the edge of margin. So the user is advised not to use such pattern over long time.
3. Long-time display of electronic games and computer static images may result in local residual image, and the screen may get burnt and result in residual image on the screen. To avoid this, you need to lower the screen brightness and contrast during use.

For any image residual shadow, local residual image and trace problems with the TV screen due to the said reasons, the display screen is not within the range of warranty.

The TV set is a Type II equipment, and used without requiring grounding.

Tips for energy saving:

1. Please choose AC power off (turn off the TV through the power switch) when not viewing TV program to minimize energy consumption.
2. Under condition that the view quality is not impacted, reduce the brightness of display screen to minimize the energy consumption of TV during use.

More Product Features, you can see the TV Featuring Application Guide.



Important Safety Instructions

Check the Symbol



Triangle enclosing a lightning arrow is a warning symbol, reminding you of the high voltage danger in the product.



Triangle enclosing an exclamation mark is a warning symbol, reminding you of the important notes related to the product.

- Attention.

The correct way.

✘ The wrong way.

-> Next step.

Alerts: Before using the product, please read the following clauses carefully.

1 Power and signal

- ⚠ When it is rainy, please pull out the power plug, CATV plug or outside antenna plug to avoid any possible damage to the TV set. Do not touch the inducting wire of the antenna.
- ⚠ Where the MAINS plug or an appliance coupler is used as the disconnect device, the disconnect device shall remain readily operable.
- ⚠ If you do not use the product for a long time, please pull out the power plug.
- ⚠ If you find abnormal sound or smell, or there is sound but no image, please turn off the TV and pull out the plug immediately and contact the Hisense Service.
 - Please do not press the power line and signal line with other things.
 - Please do not make the power outlet overloaded, or it will result in the danger of fire.
 - Keep the power line away from high temperature and heating things.
 - There are some changes for the outdoor antenna if it stays outside for a long time, which may affect the picture quality of the TV, so please check the antenna or replace it regularly.
 - Do not place containers with water on the TV, such as a cosmetic or medicament.
 - If foreign objects or water falling into the television, unplug the power cord and timely and Hisense Services.
 - Beware of children standing on top of a TV or climb to the television.
 - After the TV from the cold to a warm area where, for the full distribution of drying condensation inside the machine, you should place some time after the power is turned on.
 - To prevent injury, you must follow the installation instructions of the device after the installation base, placed on a horizontal table, or is not installed base, use can be fixed to the wall after wall mounting.
 - Do not expose the battery to sunshine, fire and other excessive heat, or there will be an explosion hazard.

2 Maintenance

- Do not clean this unit with volatile oils or dilution, which may cause cabinet deterioration or damage its coating surface.
- If the cabinet becomes dirty, please clean it with a soft cloth which has neutral detergent wet with water.

3 LCD display instruction and maintenance

- △ LCD display panel is the advanced S&T product, composed of several millions of Movie transistors inside. There can be dark or bright spots appearing on the panel. please note that this is a normal phenomenon, which does not affect the overall performance.

The incorrect maintenance will lead to damage to the LCD screen, which will affect the image effect, so you must pay attention to the following items:

- △ Don't clean the screen with the organic solvents, such as alcohol, gasoline, etc. or chemical reagents ,such as acid, alkali, etc.
- △ Do not clean the screen with any kind of detergent.
- △ After the TV is turned off, you, when necessary, can clean the screen with a clean and soft cotton cloth to properly safeguard it, but repeatedly cleaning with force is prohibited.
 - Please do not directly touch the screen with your fingers, which may damage the screen surface. What's more, the oil and fat on the screen is difficult to remove.
 - Please do not put pressure on the LCD, for the LCD screen is delicate and vulnerable.
 - The hard object is not allowed to touch the LCD screen, for it is easily scratched.

4 Product

- Please do not try to decompose any part of the product, which may cause damage to the product as well as harm to the human. And it will also make you face the product warranty failure.
- Please do not remove the back cover. The adjust and check inside the unit should only be carried out by the professional technicians.
- Please do not cover or block the heat-radiating holes in order not to hamper the unit to give off heat.
- Please do not stick the sharp objects, metal, or liquid into or use them to touch the signal interface or heat-radiating holes in case of short circuit or damage to the product.

5 Method of placement

Even and steady occasions.

- × Places under direct sunshine or close to heating devices.
- × Places with poor ventilation.
- × Places close to furnace or places to which water, oil or smoke is easy to enter.
- × Places where ventilating openings are closed.

- × Unsteady places.
- × Places suffering from easy vibration.
- × Places of lot of dust or moist places.
- × Places of high temperatures.
- In the case where such substances that are painted with paint or organic solvent and grease, etc. on the surface of the TV cabinet, the chemical reaction may be occurred in between the rubber cushion on the base and such substances hereinbefore, which may cause a slight corrosion on the surface of the TV cabinet. Therefore, users are recommended to firstly put a layer of protective material (such as pressboard or glass sheet, etc.) on the TV cabinet and then place the TV set.

6 Watching TV

- Watch TV at a proper distance, and the best distance is 3 to 4 times the length of the vertical distance of LCD.
- Keep the lighting indoors bright enough to read newspaper.
- The volume should be properly set in order not to disturb your neighbors, esp. when it is during the night.

7 Others

- It is recommended that 2 or more people should load, unload and carry the unit; try to avoid any crash when carrying the unit, and protect the LCD screen in particular.
- If you touch the LCD screen when turning on or off the TV, you can feel the slight electric shock, which is the so-called electrostatic and does no harm to your health.
- Plastic shell newly purchased television, internal transformer insulating paint, rubber and other pieces of furniture will be like a new purchase as distributing certain smell, temperature, odor will be more apparent. The odor is determined by the nature of the material. Materials scheme we use fully meet the requirements of environmental regulations sales regions, so consumers can be assured. TV odors over time gradually reduce and eventually disappear, consumers should pay attention to use ventilation environment.

8 Securing the Installation Space

- Never cover or block the heat-radiating holes.
- Avoid operating the TV below 5 °C.
- Make sure that your TV has adequate air circulation. Allow enough space around the TV as shown below.

Install with stand:

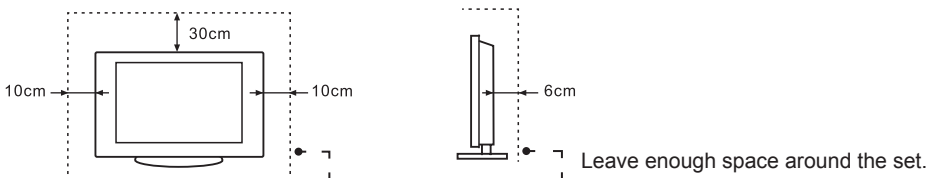

Install on the wall:

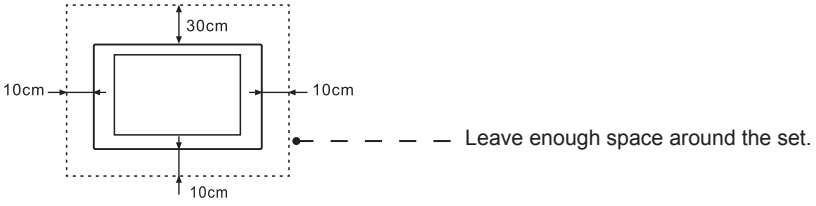

- Never install the TV set as follows:

Inadequate air circulation can lead to overheating of the TV and may cause damage to your TV or cause fire.

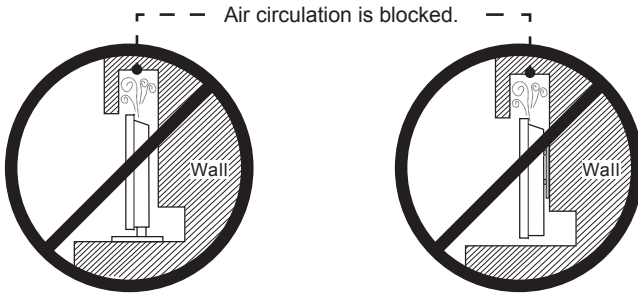



Contents

Accessories List.....	2
Installing the Stand.....	2
Remote Control.....	3
Control Panel.....	4
Terminal Introduction.....	5
Connection Description.....	6
Using the TV for the First Time.....	10
Others.....	11
Specifications.....	13

1

Accessories List

User Manual
Warranty Card

Remote Control
Power line

AAA Battery
Screw

Comp Adapter
AV Adapter

2

Installing the Stand

- Carefully place your TV face-down on a soft, flat surface to prevent damage to the TV or scratching to the screen.
- Install the base stand with the provided screws in the accessory bag in case of causing damage to TV.
- Appearance prevail in kind.

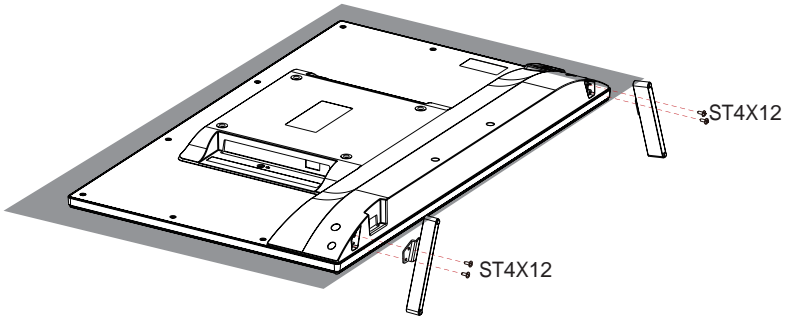

Insert the base stand into the bottom slots of the TV, use the four screws to the base stand and TV together.

3

Remote Control

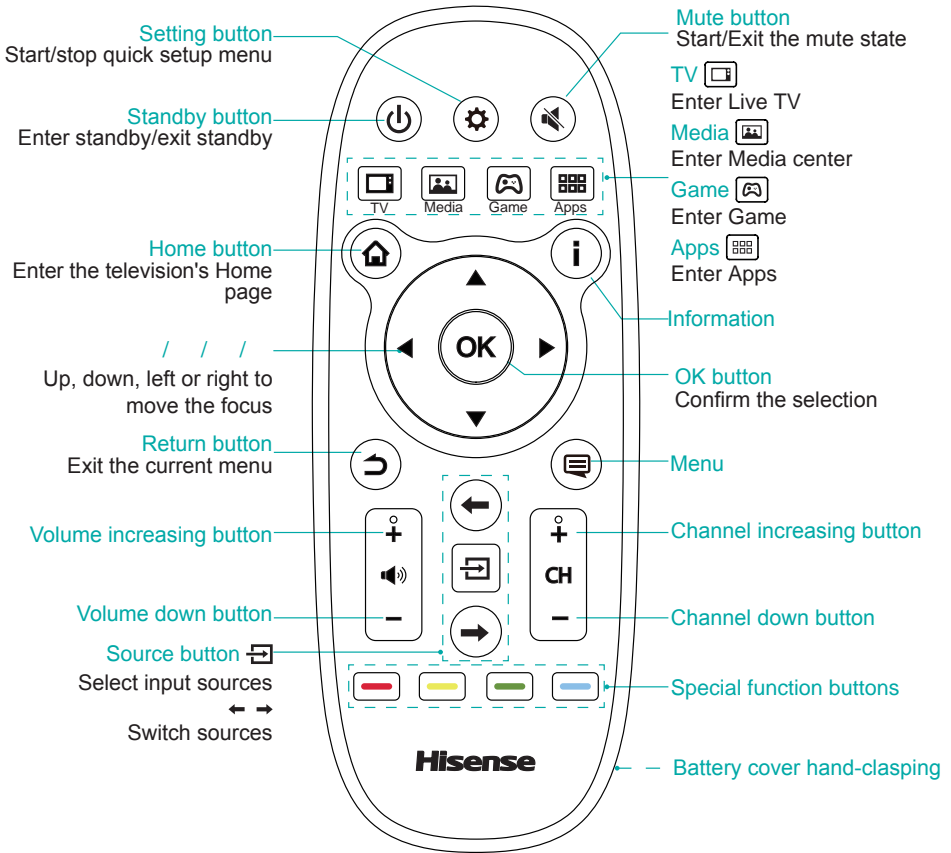

·Change the battery

1. Open the battery cover, battery cover separated from the body in a remote control, in the battery cover hand-clasping place.
2. Install two AAA size (1.5V) batteries. Match the "+" and "-" signs on the batteries to the signs on the battery compartment.
3. Close the battery cover until the body is fully consistent with the remote control.

·The effective range of remote control

1. Remote control distance: In front of the remote distance 8 meters effective range.
2. The remote control angle: taking the television infrared light receiver window as an apex, 6 meters away, its controlled angle (left to right) is within 30 degrees, while the vertical angle (up to down) is within 15 degrees.

·Attention

1. If the remote control doesn't work normally, unstable, or cannot control the TV, please update Battery.
2. If you do not use the remote control for a long time, remove the batteries. (Used batteries pollute the environment, properly handle.)
3. In order to achieve the best remote receiving effect, the remote control of the remote control transmitting window is aimed at the remote control operation of the remote control receiving window.

4

Control Panel

Hold the **OK** button to pop up the button menu.

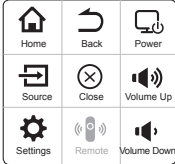





Control panel on the back shell (see the effect from the rear).



Remote control receiver window/
Power indicator

Note: This machine does not support retrieve remote control functions.

Item	Description
Power button I O	Turn on or off the TV set.
Remote control receiver window	Receive remote signals from the remote control.
Power indicator	Boot blue light, red light standby.
	Select the previous favorite channel / Move the pointer or focus position of the screen to the left.
	Select the next favorite channel / Move the pointer or focus position of the screen to the right.
	Confirm the your choose in some menu. / Hold the ok button until the button menu appears.
	Select the next channel / Move the pointer or focus position of the screen up.
	Select the previous channel / Move the pointer or focus position of the screen down.

5

Terminal Introduction

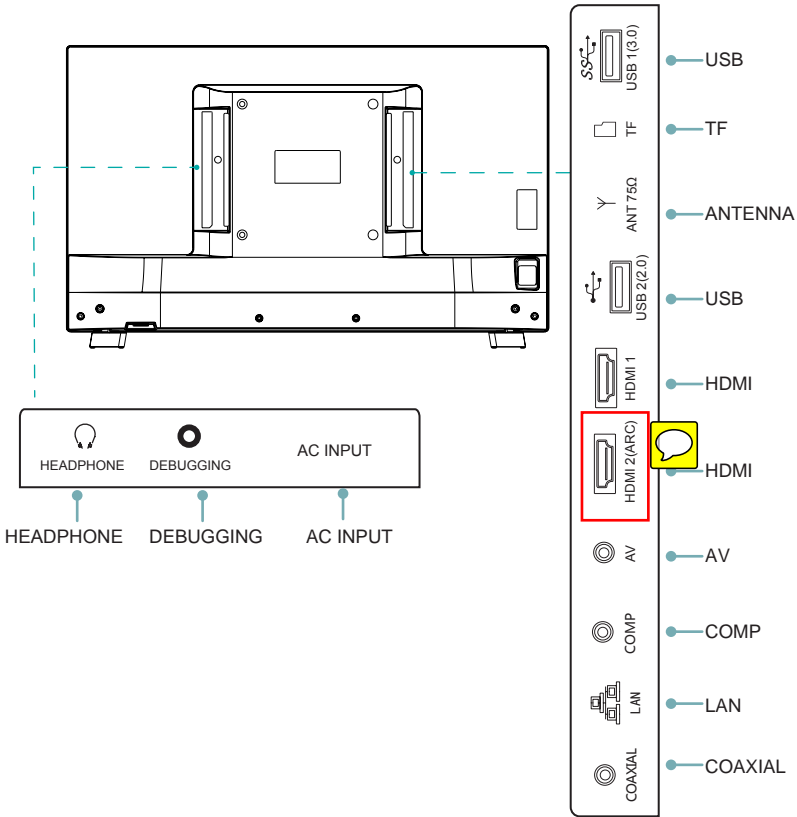

【NOTES】

- As a result of time consumption of power down of power supply and system processing, please don't switch on and off continuously and fast, otherwise it may cause abnormal working.
- In the home page and menu operation, you can use the arrow button to select, part of the interfaces and applications does not support the button for the time being.
- Some external devices are in possible insert into this set. Please replace with appropriate external signal cable or increase the adapter to match with the port in such case.
- The factory debugging use only, do not insert any terminal.

6

Connection Description

- Selecting signal input

To enjoy the show from a cable set-top boxes and other external devices, select mode with this device is connected, press the **Source** button to enter the **Source** menu, select the local port corresponding to the signal source in the **Source** menu.

- Connecting an Antenna or Cable

Wired / Antenna input: It can be connected to cable networks or antenna.

- Need to switch Analog TV, Digital TV-DTMB signal, please press the **Settings** button to enter the setup menu, select **Tuner** to switch.

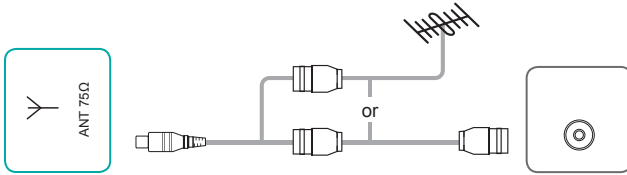

- Connecting a USB Device

USB: This machine has the USB standard interface, which can be connected to standard equipment with USB1.1, USB2.0 , including hard disk, U-disk and so on. When multifunction USB external device is a combination device, it is recommended that you use USB 1 jack. When using the USB2 interface, it is recommended that you use the USB extension cable.

The total current should be no more than 1400 mA when all the USB jacks are connected with external devices. Hisense warranty does not cover the TV damages and issues caused by the current overload.(Only USB 1 jack supports USB 3.0 devices)

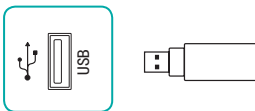

- Connecting an Ex-Speaker

COAXIAL: Use a coaxial cable to connect the TV's COAXIAL jack to the Audio Amplifier, then connect the Audio Amplifier to the external speaker.

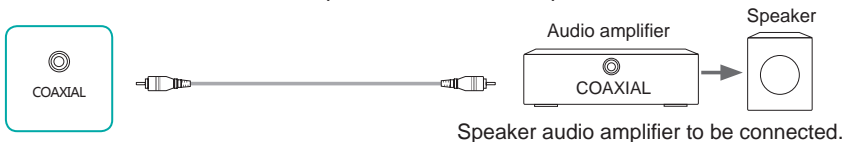

· Connecting an A/V Device

With the HDMI Cable

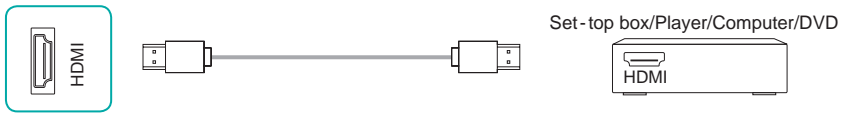

HDMI: HDMI is also called as high-definition multi-media port. As the latest generation of port, the digit audio signal and video signal can be transmitted with a cable without compressed.

- HDMI supports multi-channel digital audio, HDMI port can be connected to external devices, such as: set-top boxes, players, computers with HDMI output and so on.
- The connection between sending and receiving equipment don't need separate audio cable.

【NOTES】

- For video format supported by HDMI input, refer to the specifications.

- Only HDMI 2 port supports ARC functionality.



With the AV Cable

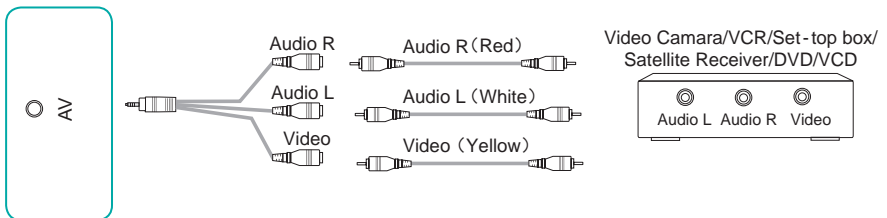

Video input: can connect video output devices.

Audio input: can connect audio output device.

- Connect the TV's AV jack to video output jack of the external A/V devices (VCD, DVD, VCR or Camcorder).
- Connect the TV's AUDIO IN jack to audio output jacks (Audio Left/Right) of the external A/V devices.

【NOTES】

- The TV's AV input port are connected to external devices with "AV adapter" provided.
- Make sure that when you switch to access the audio component, otherwise the sound will be abnormal.

With the Component Cable

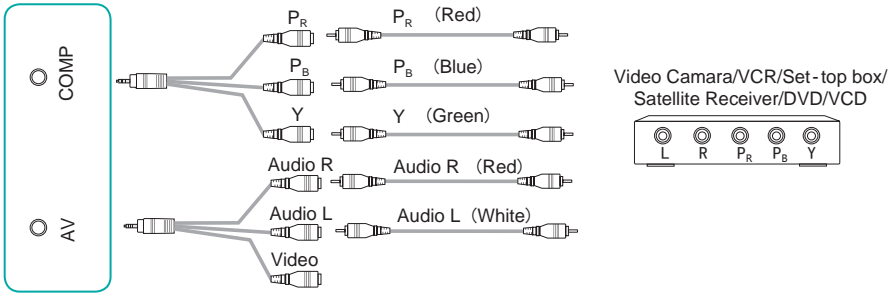

- Connect the TV's COMPONENT jack to component video output jack (Y, PB, PR) of the external A/V devices (VCD, DVD, VCR or Camcorder).
- Connect the TV's AUDIO jack to audio output jacks (Audio Left/Right) of the external A/V devices.
- Component output jacks in VCD/DVD may be marked with Y, B-Y, R-Y or Y, C_B, C_R.

【NOTES】

- The component video signal are connected to external devices with "Comp adapter" provided. The component audio signal are connected to external devices with "AV adapter" provided.
- For video format supported by component input, refer to the specifications.
- Please make sure that the audio connects, otherwise the sound will be abnormal.

• Connecting a TF card

Connect to the TF jack in the TV with TF card (According to illustration: keep the unfilled corner up and toward the jack).



• Connecting a Headphone

While the headphone is connected, the sound from the built-in speakers will be disabled.

Headphones can be connected to the HEADPHONE jack on the TV.

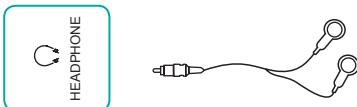

· Connecting a network

LAN: It can be connected to the network cable for Internet access.

Enter the [setup](#) menu, select [Settings](#)→[System Settings](#)→[Network Settings](#), click into [Network Settings](#) menu.

The wireless network connection

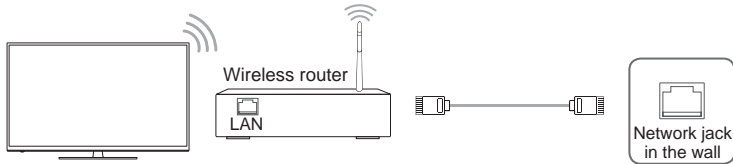

The TV can directly receive network signals via wireless router.

- 1 Select [Wi-Fi](#) in the [Network Select](#), the list of available wireless networks will be displayed in [Wi-Fi settings](#) automatically.
- 2 Enter Wireless Setting interface, select a wireless network, input password and click [Connect](#). (If the network is not encrypted, select "Connect" icon to connect directly.)
- 3 If the network you want to connect not appeared in the list, select [Wi-Fi advanced](#) and select the [+ Other Network...](#) to manually enter the network SSID, select the encryption mode and input password, click [Save](#).

The wired network connection

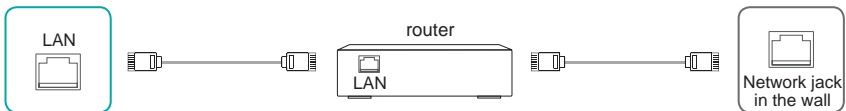

Automatically obtain IP

- 1 Select [Ethernet](#) in the [Network Select](#), [Ethernet Settings](#) menu to select the [DHCP](#), TV will automatically obtain IP address, connect to the network.
- 2 If the connection fails, please retry or select [Static IP](#) to manually input connection.

Manually enter IP

- 1 Select [Static IP](#).
- 2 Enter the IP address, Netmask, DNS address and Gateway address in the [Configure Ethernet device](#), click [Save](#).

The PPPOE network connection





- 1 Select [PPPoE\(ADSL\)](#) in the [Network Select](#).
- 2 Input the user name and password, click [Connect](#).

7

Using the TV for the First Time

1 Turning the TV On or Off

- Use an AC cord to connect the TV's Power input jack AC outlet.
- Press the **Power button**  on the TV set. When the TV is on, press the **Standby button**  on the remote control, and the TV will enter Standby mode. Press this button again, and you can watch TV normally.
- Press the **Power button**  again to turn off the TV.

2 Changing the Channel and Volume

- Press the **CH+ / CH-** buttons on the remote control to change the channel.
- Press the **◀/+ / +/▶** buttons on the remote control to adjust the volume.

【NOTES】

- In order to save power consumption, set the TV in Standby mode if you do not watch TV for a short time, if you do not watch TV for a very long time, shut down the main power of the TV.
- If the TV is turned off, to turn it on again, please wait 5 seconds at least in case the abnormal phenomena occurred.



3 Adjusting the machine settings

Menu is a easy interactive window to achieving most of the basic functions of the TV.

- Press the **⚙️ button** to enter the settings interface, you can adjust the various settings.
- In each level of menu, you can select the following operations according to different menus:

Press **◀/▶ buttons** or **▲/▼ buttons** to select an item

Press the **OK button** to confirm operation or enter the submenu.

Press the **◀/▶ buttons** to adjust the value

Press **▲/▼ buttons** to select the item

- Press the **↩ button** to return to the previous menu or exit the menu.

8

Others

1 Trouble Shooting

When there is something wrong with your TV, you can try turning off the TV and then restart it. You can also operate according to the following chart. If the problem still cannot be solved, please contact the professional technicians.

Symptoms	Possible Solutions
No sound or picture	<ul style="list-style-type: none"> · Check if the power line is in the outlet and if it has electricity. · Check if you have pressed Power button on the TV or Power button on the remote control. · Check the setting of picture brightness and contrast. · Check the volume.
The picture is normal but there is no sound	<ul style="list-style-type: none"> · Check the volume.
No picture and white or black picture	<ul style="list-style-type: none"> · Adjust Picture Setting. · Check Color System.
The sound and picture are interfered	<ul style="list-style-type: none"> · Try to find the appliance affecting TV set, and move it far away from the TV set. · Try to insert the power plug of the TV set into another outlet.
Unclear picture or picture with snow	<ul style="list-style-type: none"> · Check the direction, position and connection of your antenna. · Adjust the direction of your antenna or reset or fine tune the channel.
The remote control does not work	<ul style="list-style-type: none"> · Change the batteries in the remote control. · After removing the battery, any pressing a few keys, and then reinstall the battery. · Check the contacting points of the batteries. · Check if there is obstruction between the remote control and the monitor. · Check if the batteries are correctly installed.
H/V strip or the picture shaking	<ul style="list-style-type: none"> · Check if there is interfering source nearby, such as appliance or electric tools.

2 Instructions



The terms HDMI and HDMI High-Definition Multimedia Interface, and the HDMI Logo are trademarks or registered trademarks of HDMI Licensing LLC in the United States and other countries.



Dolby, Dolby Audio, and the double-D symbol are trademarks of Dolby Laboratories.



Manufactured under license under U.S. Patent#'s: 5,451,942; 5,956,674; 5,974,380; 5,978,762; 6,487,535 & other U.S. and worldwide patents issued & pending. DTS and the Symbol are registered trademarks, & DTS 2.0+ Digital Out and the DTS logos are trademarks of DTS, Inc. Product includes software. © DTS, Inc. All Rights Reserved.

【STATEMENTS】

- The pictures and instructions in the user manual are only for reference, and may be different from appearance of actual products. Please make the object as the standard. (This statement is applicable throughout this user manual)
- Any change to quality upgrade, product design and specification will not be subject to any prior notice.
- User manual is only part of the application guidance instructions, and other applications can refer to the prompt in the application instructions.

9

Specifications

MODEL		LHD32K3500HK
Dimension (WxHxD)(mm)	Without stand	737 × 438 × 64
	With stand	737 × 463 × 130
Weight(kg)	Without stand	6.1
	With stand	6.3
Active screen diagonal size (cm)		80
Screen resolution		1366 × 768
Power consumption		55W
Audio power		6W+6W
Standard		Q/0202RSR 609
Power supply		~ 50/60Hz 160-240V
Receiving system	RF	PAL/I, DTMB
	AV	PAL, NTSC
Channel range		C01 ~ C57CATV Z01 ~ Z38
Environmental conditions		temperature 5 ~ 35 humidity 20% ~ 80%RH atmospheric pressure 86kPa ~ 106kPa
Antenna input		75
DTV specification		Frequency: 474MHz-866MHz Transmission channel bandwidth: 8MHz Modulation : 64QAM, 16QAM, 4QAM Frame Header: Pn945 Symbol Interleaving: 720 Code Rate: 0.4, 0.6 Video decode Format: H.264, MPEG-2 Audio decode Format: MPEG-1, AC-3
Analogue Tune		VHF-L:48.25 ~ 168.25MHz VHF-H:175.25 ~ 463.25MHz UHF:471.25 ~ 863.25MHz

Below is the list of video format compatible:

Formats	Video decoding				Audio decoding
	Type	Resolution (max)	Bit rate (max)	Frame rate (max)	
.avi	Xvid	1280 × 720	40Mbps	30fps	AC3, MPEG1(Layer1,2,3)
.avi .mpg .ts	MPEG2	1920 × 1080	40Mbps	30fps	AC3, MPEG1(Layer1,2,3)
.ts .mkv .avi .mp4 .flv	H.264	1920 × 1080	40Mbps	30fps	AC3, AAC, MPEG1(Layer1,2,3)
.avi .mpg .mov	MPEG4 ASP	1920 × 1080	40Mbps	30fps	AC3, MPEG1(Layer1,2,3)
.mkv .mp4	H.264	3840 × 2160	100Mbps	30fps	MPEG1(Layer1,2,3), ACC
.rm .rmvb	RV30 RV40	1920X1080	10Mbps	30fps	Cooker
.ts .mkv .mp4	H.265	3840 × 2160	100Mbps	60fps	AAC

【STATEMENT】

We can not promise that this set would support all the formats listed above, as the programming tools are different.

HDMI Input	
RGB/60Hz	640 × 480、 800 × 600、 1024 × 768
YUV/50Hz	576i、 576p、 720p、 1080i、 1080p
YUV/60Hz	480i、 480p、 720p、 1080i、 1080p
Component Input	
480i、 480p、 576i、 576p	
720p/60Hz、 1080i/50Hz、 1080i/60Hz、 1080p/50Hz、 1080p/60Hz	